

WORLD MARKET®

Assembly Instructions

BRADFORD LEATHER WOOD CHAIR
SKU- 623433, 623434, 633473

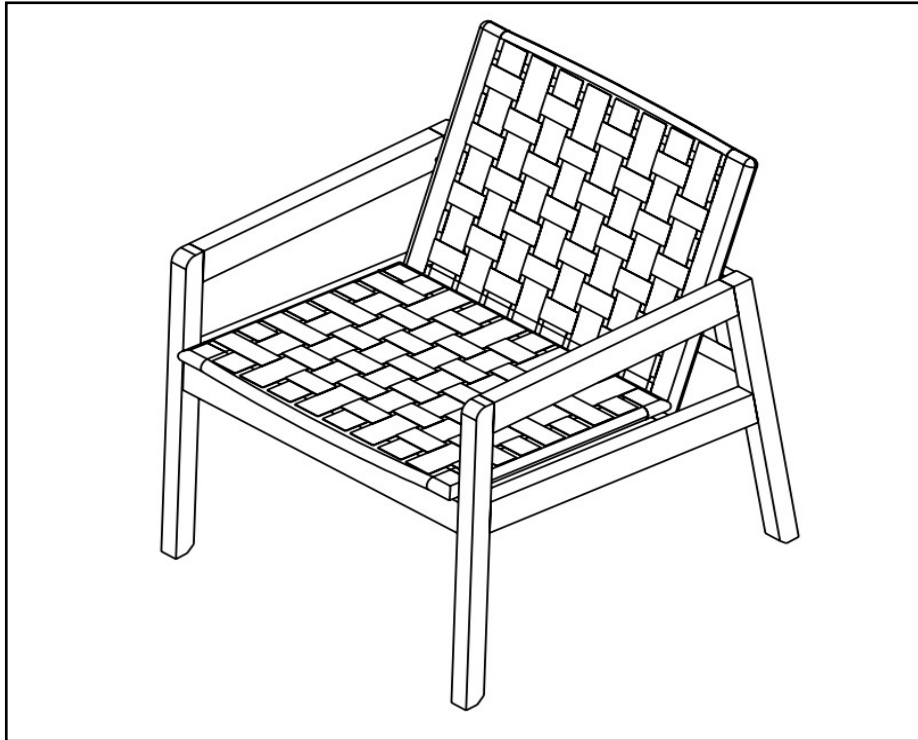





THANK YOU FOR YOUR PURCHASE. IF YOU HAVE ANY QUESTIONS
PERTAINING TO THE ASSEMBLY OF THIS FURNITURE PIECE, PLEASE CONTACT
THE NEAREST WORLD MARKET STORE.
IF YOU ARE NOT NEAR A STORE, PLEASE CALL OUR CUSTOMER SERVICE CALL
CENTER TOLL FREE AT 877- 967-5362 FOR ASSISTANCE.



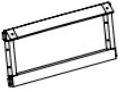

**ALL PRODUCTS SOLD AT WORLD MARKET ARE NOT
FOR COMMERCIAL USE AND ARE INTENDED FOR
RESIDENTIAL USE ONLY**

Component List

LABLE	IMAGE	DESCRIPTION	QTY
A		Seat	1
B		Left Leg Frame	1
C		Right Leg Frame	1
D		Backrest	1
E		Back Support	1

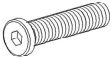
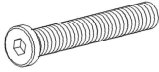
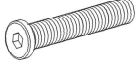
Hardware List

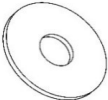
LABLE	IMAGE	DESCRIPTION	QTY
H-1		Small Allen bolt M6 x 45mm	6
H-2		Large Allen bolt M6 x 70mm	2
H-3		Medium Allen bolt M6 x 60mm	4
H-4		Lock washer M8 x 12 mm	12
H-5		Flat washer M8 x 15 mm	12

Tool List

LABLE	IMAGE	DESCRIPTION	QTY
T-1		Allen key 4 mm	1

Assembly Preparation

Before Beginning:

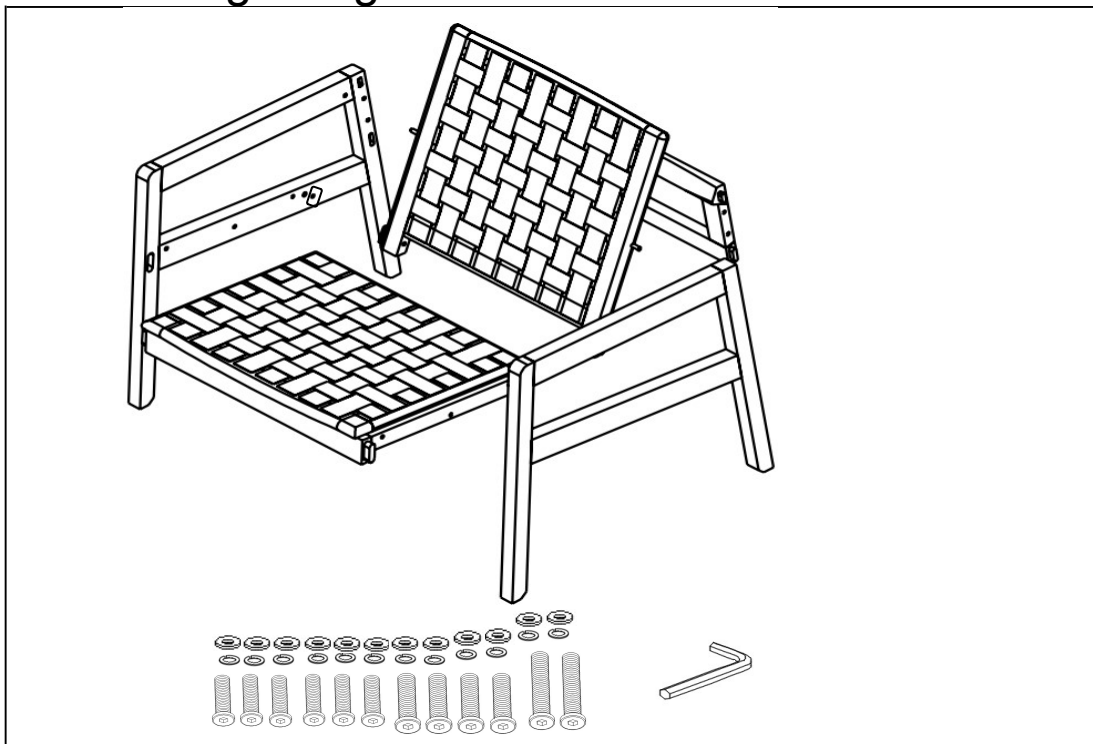

- **Unpack all hardware bags and components to ensure you have all parts**



- **Read instruction, cover to cover**



- **Have 2 adults on hand for assembly**



- **Do not assemble on flooring or carpet**



- **Assemble on a clean non-marring surface (packing foam)**



- **Save all packaging until finished**



- **In case of missing parts, please contact your nearest World Market store or call our customer service call center at call 1-877-967-5362.**



- **WARNING: Small parts are a choking hazard. Adult supervision is required before, during and after assembly.**

Assembly Steps

Step 1

Hardware use-

1-(H1)-3x

2-(H4)-3x

3-(H5)-3x

PLEASE MAKE NOTE OF THE DIFFERENT BOLT SIZE AND ENSURE YOU ARE USING THE CORRECT SIZE BOLT FOR EACH STEP.

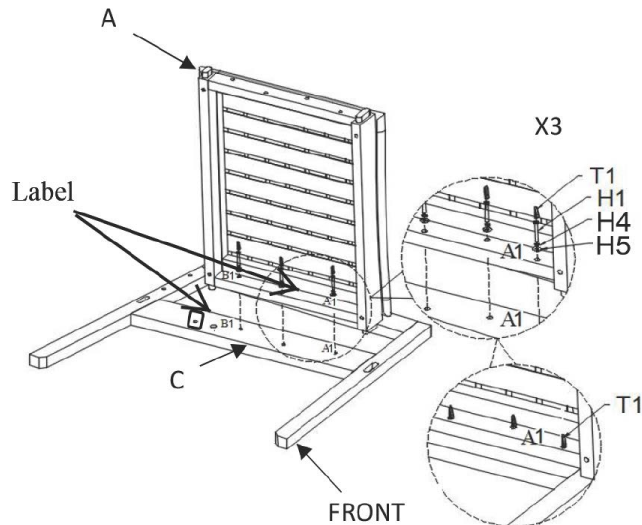

Lay a Right Leg Frame (C) down on a padded non-marring surface. Take Seat (A), ensuring to match label A1-A1, B1-B1 as illustrated. Secure connections using Small Allen bolt (H1), Lock washer (H4) and Flat washer (H5) in the sequence as shown above. Do engage all hardware first, then loosely tighten using provided Allen Key (T1). Do not yet fully tighten.

Step 2

Hardware use-

1-(H2)-1x

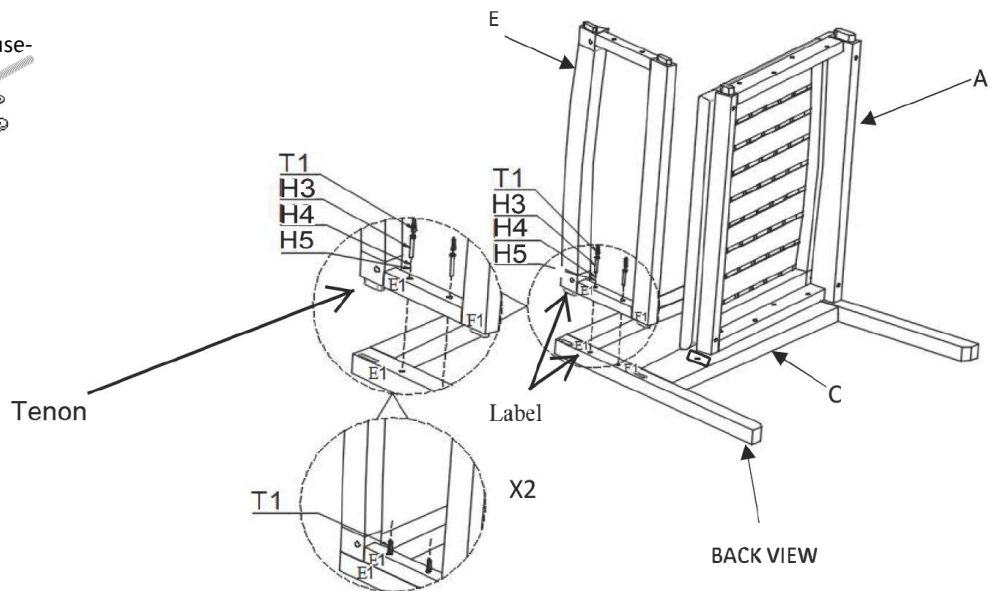

2-(H4)-1x

3-(H5)-1x



Position the Back Support (E) onto the Right Leg Frame (C), ensuring the labels match E1-E1, F1-F1 and that the tenons are inserted into the predrilled mortises. Secure connections with Medium Allen Bolts (H3), Lock Washers (H4) and Flat Washers (H5) in the sequence as shown above. Engage all hardware first, then loosely tighten using provided Allen Key (T1). Do not yet fully tighten.



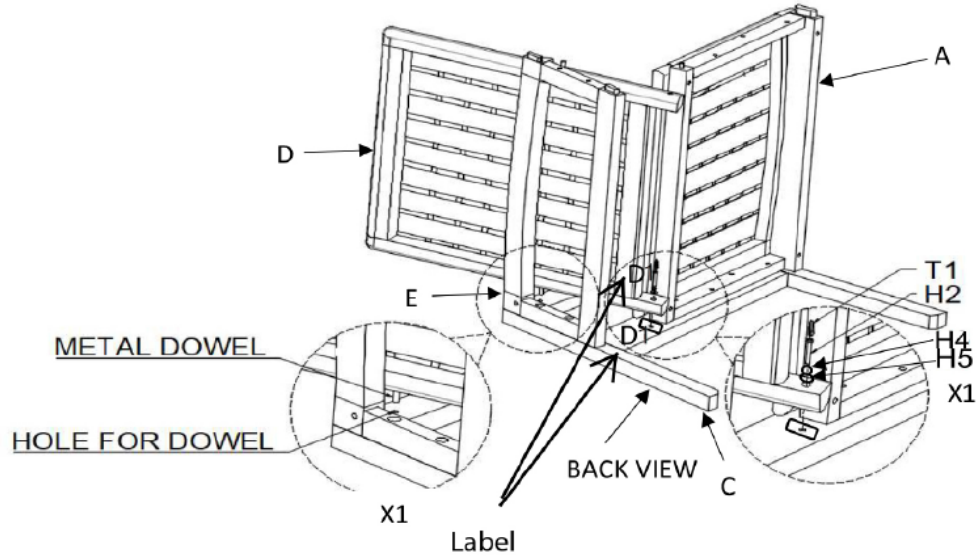

Step 3

- Hardware use-
- 1-(H2)-1x 
 - 2-(H4)-1x 
 - 3-(H5)-1x 



Position Backrest (D) onto assembly. Insert the metal dowel into the predrilled hole. Ensure the labels match (D1-D1). Secure the connection with Long Allen Bolts (H2), Lock Washers (H4) and Flat Washers (H5) in the sequence shown above. Engage all hardware first, then loosely tighten using provided Allen Key (T1). Do not yet fully tighten.

Step 4

- Hardware use-
- 1-(H1)-3x 
 - 2-(H2)-1x 
 - 3-(H3)-2x 
 - 4-(H4)-6x 
 - 5-(H5)-6x 

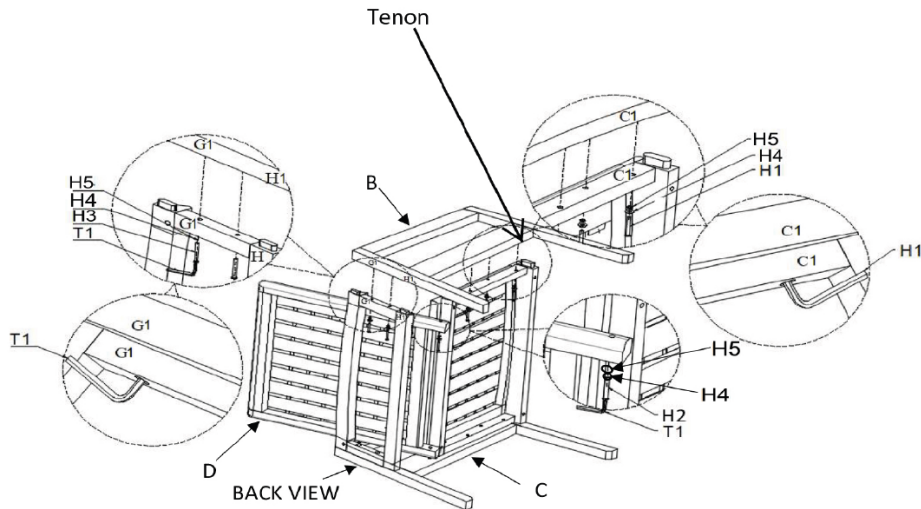

Position the Left Leg Frame (B) onto assembly as shown, ensuring all labels are matching. Insert tenons into predrilled mortises as shown above. Repeat steps 1, 2, and 3 to secure all connections, making sure to use the appropriate hardware for each. Engage all hardware first, then loosely tighten using provided Allen Key (T1). Now fully tighten all the hardwares from step 1 to 4 using provided Allen Key (T1). Do not over tighten.



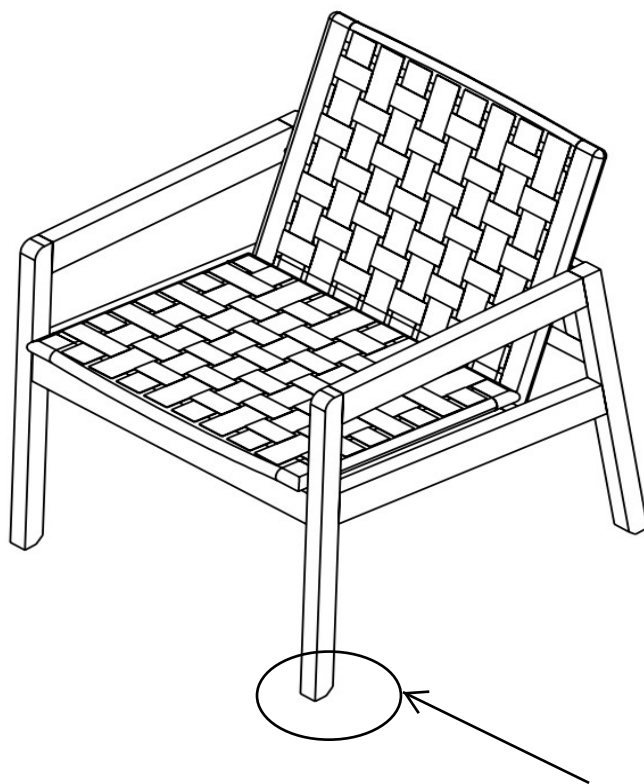





Step 5



Levelers can be used for adjustment if required

With the assistance of second person, turn the product in upright position. Check all the hardware from step 1 to 4. Now product is ready for use.

Care & Maintenance

-  • Do not put hot items directly on furniture surface
 -  • Do not clean furniture with harsh cleansers or polish.
 -  • Do not place furniture in direct sunlight.
 -  • Do not place furniture near heating or cooling vents.
 -  • Do not write on furniture without a padded barrier to protect the surface.
 -  • Do not place furniture outside. For in door use only.
 -  • All products sold at World Market are not for commercial use and are intended for residential use only
-
-  • Dust and pick-up spills using a clean, non-colored, lint-free dry cloth.

WORLD MARKET LIMITED ONE-YEAR WARRANTY – Indoor Furniture

For your customer satisfaction, this product carries a LIMITED ONE-YEAR WARRANTY from the date of purchase. This limited warranty only applies to World Market brand furniture, and not to other furniture brands sold on World Market's website.

Where applicable, the limited warranty provides coverage for:

1. **Manufacturing, Material and Workmanship Defects:** Includes defects related to core frame/structure substrates (wood and metal); cracking, splitting, or complete breakage of hardwood, plywood or medium density fiberboard (MDF); cracking, splitting or lifting of wood veneer or laminated top surfaces caused by process failure; broken welds or improperly coated metal frame components (powder coating or painted); fabric or leather material defects including tears, misprints, fraying, crease marks, skip stitches or open seams; support webbing material and sinuous spring defects or damage, including method of attachment to frame; and other component failures that are a direct result of manufacturing or workmanship defects.
2. **Cushions & Cushions with Enclosed Steel Pocket Coils:** Failed or ruptured steel pocket coils enclosed inside of seat cushions, or loss of resiliency from a material breakdown of foam or fiber filling, which should not be confused with softening or settling during normal use.
3. **Leather:** Splitting or cracking of leather material. NOTE: The warranty does NOT cover natural hide markings, variations in the leather color or grain due to the authentic natural properties of processed animal hide.
4. **Bonded Leather or Bi-cast Leather:** Separation of the polyurethane coating, peeling or cracking of the inner layer or at the bonded seam edges (bi-cast straps).
5. **Furniture Components (Hardware & Mechanisms):** Includes defects to pre-installed components or hardware provided to the customer for assembly such as office chair hydraulic lifts, lift mechanisms, metal bases and casters, swivel plate mechanisms; for drawers, metal glides, handles/knobs; for doors, hinges, magnetic latches; and other components such as bent or stripped threaded leg posts and adjustable levelers. For missing, damaged, corroded, or misplaced hardware components such as bolts or washers, please contact Customer Service at: 877-967-5362.

This LIMITED ONE-YEAR WARRANTY does NOT cover:

1. Damage due to mishandling during transportation from store or transportation without original protective packaging.
2. Abuse, negligence (product misuse) or wear and tear that may result in or from:
 - a. **Wood & Veneer:** Mishandling, exposure to moisture, peeling or discoloration caused by exposure to moisture or excessive sunlight, heat; splintered, dented or nicked panels, legs or component edges or paint/finish blemishes; or treatment with corrosive chemicals (dyes, inks, paints or harsh cleaning products).
 - b. **Fabric & Leather (Including Bonded or Bi-Cast Leathers):** cuts, punctures, tears, burns, pet damage, or treatment with corrosive chemicals (dyes, inks, paints or harsh cleaning products), exposure to direct sunlight, fire, high heat, water, or any bright light source (natural or artificial) that may cause splitting, peeling or flaking with time.
 - c. **Foam (Cushions):** Flattening, relaxing or settling/softening of foam components that comes with normal use.
 - d. **Hardware Components:** improper installation or misuse/substitution of hardware components not defined in the Assembly Instructions for the product (if applicable)
3. Damage due to environmental exposure to direct sunlight, fire, high heat, water or extreme humidity, any bright light source (natural or artificial), or any environment that the product is not intended for.
4. This warranty is applicable for indoor furniture products purchased for residential use only.

For additional information on returns, please visit: <https://www.worldmarket.com/category/customer-service/returns.do>

All products sold at World Market are NOT FOR COMMERCIAL USE and are intended for residential use only. Products purchased for commercial use will VOID all warranty provisions as listed above.

Any claims under this LIMITED ONE-YEAR WARRANTY are valid and applicable only as to the original purchaser and must be accompanied by proof of purchase. Warranty claims should be submitted to a World Market store or through World Market Customer Service Call Center, Toll Free at 877-967-5362.

For valid warranty claims, World Market will repair or replace the product, or offer a full or partial credit, in the sole discretion of World Market. This LIMITED ONE-YEAR WARRANTY gives you specific legal rights and you may also have other rights which vary from state to state.